



# Universal Development Kit User Guide

Part No. 875-0284-000 Rev E1



This device complies with part 15 of the FCC Rules. Operation is subject to the following two conditions:

- (1) This device may not cause harmful interference, and
- (2) this device must accept any interference received, including interference that may cause undesired operation.

## Copyright Notice

Copyright Hemisphere GNSS, Inc. (2013). All rights reserved.

No part of this manual may be reproduced, transmitted, transcribed, stored in a retrieval system or translated into any language or computer language, in any form or by any means, electronic, mechanical, magnetic, optical, chemical, manual or otherwise, without the prior written permission of Hemisphere GNSS.

## Trademarks

Hemisphere GPS<sup>®</sup>, the Hemisphere GPS logo, COAST<sup>™</sup>, Crescent<sup>®</sup>, Earthworks<sup>®</sup>, Eclipse<sup>™</sup>, e-Dif<sup>®</sup>, L-Dif<sup>™</sup>, miniEclipse<sup>™</sup>, PocketMAX PC<sup>™</sup>, PocketMAX<sup>™</sup>, PocketMax3<sup>™</sup>, S320<sup>™</sup>, SBX-4<sup>™</sup>, SureTrack<sup>®</sup>, Vector<sup>™</sup>, XF1<sup>™</sup>, and XF2<sup>™</sup> are proprietary trademarks of Hemisphere GNSS, Inc. Other trademarks are the properties of their respective owners.

## Patents

Hemisphere GNSS products may be covered by one or more of the following patents:

U.S. Patents				Australia Patents	
6111549	6876920	7400956	8000381	8214111	2002244539
6397147	7142956	7429952	8018376	8217833	2002325645
6469663	7162348	7437230	8085196	8265826	2004320401
6501346	7277792	7460942	8102325	8271194	
6539303	7292185	7689354	8138970	8307535	
6549091	7292186	7808428	8140223	8311696	
6711501	7373231	7835832	8174437	8334804	
6744404	7388539	7885745	8184050	RE41358	
6865465	7400294	7948769	8190337		

Other U.S. and foreign patents pending.

## Notice to Customers

Contact your local dealer for technical assistance. To find the authorized dealer near you:

Hemisphere GNSS, Inc.  
8444 N 90th St, Suite 120  
Scottsdale, AZ 85258 USA  
Phone: (480) 348-9919  
Fax: (480) 348-6370  
[precision@hemispheregps.com](mailto:precision@hemispheregps.com)  
[www.hemispheregps.com](http://www.hemispheregps.com)

## Technical Support

If you need to contact Hemisphere GNSS Technical Support:

Hemisphere GNSS, Inc.  
8444 N 90th St, Suite 120  
Scottsdale, AZ 85258 USA  
Phone: (480) 348-9919  
Fax: (480) 348-6370  
[techsupport@hemispheregps.com](mailto:techsupport@hemispheregps.com)

## Documentation Feedback

Hemisphere GNSS is committed to the quality and continuous improvement of our products and services. We urge you to provide Hemisphere GNSS with any feedback regarding this guide by writing to the following email address: [techsupport@hemispheregps.com](mailto:techsupport@hemispheregps.com).



---

# Contents

---

<b>Chapter 1</b>	<b>Universal Development Kit Overview . . . . .</b>	<b>1</b>
	What is the Universal Development Kit? . . . . .	2
	Supported OEM Boards . . . . .	2
	Supporting Documentation . . . . .	2
	UDK Components . . . . .	3
	OEM Board Integration Requirements . . . . .	4
<b>Chapter 2</b>	<b>Kit Specifications . . . . .</b>	<b>5</b>
	Cable Interface . . . . .	6
	Routing and Securing the Cables . . . . .	6
	Environmental Requirements . . . . .	7
	Powering the UDK . . . . .	7
	Serial Ports . . . . .	8
	USB Ports . . . . .	9
	LED Indicators . . . . .	9
<b>Chapter 3</b>	<b>Installing an OEM Board . . . . .</b>	<b>13</b>
	Using an Adapter Board . . . . .	14
	Installing Your OEM Board - No Adapter Board Required . . . . .	16
	Installing Your OEM Board Using Adapter Board A or B . . . . .	20
	Installing Your OEM Board Using Adapter Board C . . . . .	25
	Installing Your OEM Board Using Adapter Board D . . . . .	29
<b>Index . . . . .</b>		<b>35</b>
<b>End User License Agreement . . . . .</b>		<b>37</b>
<b>Warranty Notice . . . . .</b>		<b>40</b>





## **Chapter 1: Universal Development Kit Overview**

What is the Universal Development Kit?

Supported OEM Boards

Supporting Documentation

UDK Components

OEM Board Integration Requirements

This user guide provides detailed information on the interface and workings of the Universal Development Kit, its specifications, and how to connect a Hemisphere GPS OEM board to the Universal Development Kit.

This user guide does not cover receiver operation, the PocketMax™ utility, or commands and messages (NMEA 0183, NMEA2000® or HGPS proprietary). For information on these subjects refer to the Hemisphere GPS Technical Reference (go to [www.hemispheregps.com](http://www.hemispheregps.com) and click the GPS Reference icon).

## What is the Universal Development Kit?

The Universal Development Kit allows you to integrate a Hemisphere GPS OEM board into your design and includes the following:

- Enclosure
- Main carrier board
- Set of four adapter boards for use with small form factor Hemisphere GPS OEM boards
- Power cable and AC power supply
- Two serial cables - one straight serial cable and one null modem cable for RTK

*Note: Throughout the rest of this user guide, the Universal Development Kit is referred to simply as the UDK.*

## Supported OEM Boards

The UDK supports the following Hemisphere GPS OEM boards:

- Crescent®
- Crescent Vector™ II
- Eclipse™
- Eclipse Vector™
- LX-2™ (L-band DGPS service, L-band high precision services, L-band high precision service with GLONASS)

See Table 3-1 on page 15 for a list of specific OEM board models the UDK supports.

## Supporting Documentation

For the Hemisphere GPS OEM board you purchase with the UDK there is an Integrator Guide available for download from the Hemisphere GPS website at [www.hemispheregps.com](http://www.hemispheregps.com).

## UDK Components

Figure 1-1 shows the parts included in the UDK and Table 1-1 provides part numbers and descriptions.

*Note: The UDK does not include an antenna or antenna cable; they are available from Hemisphere GPS as accessory items.*

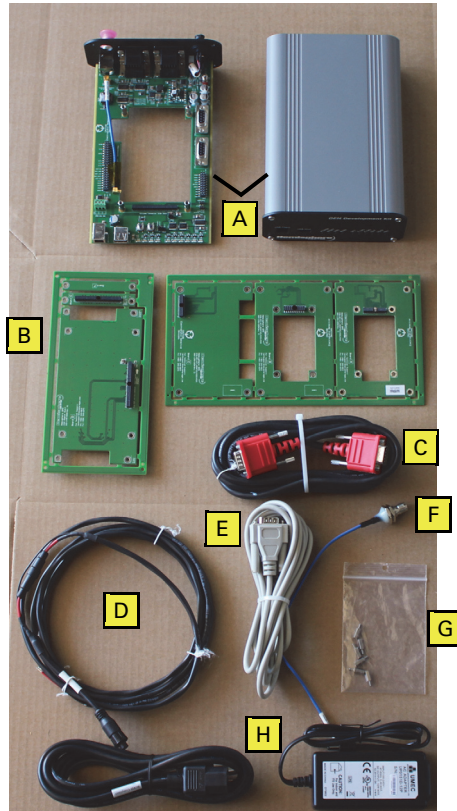

**Figure 1-1: UDK components**

**Table 1-1: UDK parts list**

Item	Part No.	Description	Qty
A	802-1066-000#	Enclosure (includes outer enclosure, front and rear panels, main carrier board, RF cable)	1
B	725-1293-000#	Adapter boards (set of 4: Boards A, B, C, D) <i>Note: Two additional adapter boards (E and F) are included with Board D and act as spacer boards.</i>	1
C	051-0172-000#	Serial data cable, DB9 male - DB9 male, 3 m	1
D	054-0009-000#	Power cable, 3 m	1



**Table 1-1: UDK parts list (continued)**

Item	Part No.	Description	Qty
E	050-0011-022#	Serial I/O cable, DB9 female - DB9 male, 3 m	1
F	053-0046-000#	RF cable, TNC female - MCX male, 280 mm <i>Note: For use with Crescent Vector II and Eclipse Vector OEM boards only.</i>	1
G	675-0002-004#	Machine screw, 4-40, 1/4", PPHC, SS	8
	676-1007-000#	Nut, hex, 4-40, SS, nylon insert	8
	678-0003-001#	Washer, lock, #4, SS	8
	680-0007-000#	Standoff, hex, M-F, 4-40, 5/16", SS	12
H	427-0030-000#	AC adapter	1
	054-0084-000#	AC cable, 2 m	1

## OEM Board Integration Requirements

Successful integration of a Hemisphere GPS OEM board within a system requires electronics expertise that includes:

- Power supply design
- Serial port level translation
- Reasonable radio frequency competency
- Understanding of electromagnetic compatibility
- Circuit design and layout

For general integration requirements refer to the appropriate OEM Board Integrator Guide available from the Hemisphere GPS website at [www.hemispheregps.com](http://www.hemispheregps.com).

---

**▲WARNING:** You may open and operate the UDK without the enclosure; however, use ESD protection when opening the enclosure and operating the UDK without the enclosure.

---



## **Chapter 2: Kit Specifications**

- Cable Interface
- Routing and Securing the Cables
- Environmental Requirements
- Powering the UDK
  - Serial Ports
  - USB Ports
  - LED Indicators

## Cable Interface

The UDK enclosure provides power, data, and GPS antenna cable interfaces. Figure 2-1 shows the various connections located on the rear panel of the UDK enclosure.

*Note: The Secondary GPS RF connection is for Crescent Vector II and Eclipse Vector OEM boards only, both of which allow for the use of two GPS antennas. You must connect this port using the provided TNC cable (Part F in Table 1-1 on page 3) to enable the functionality of this port.*

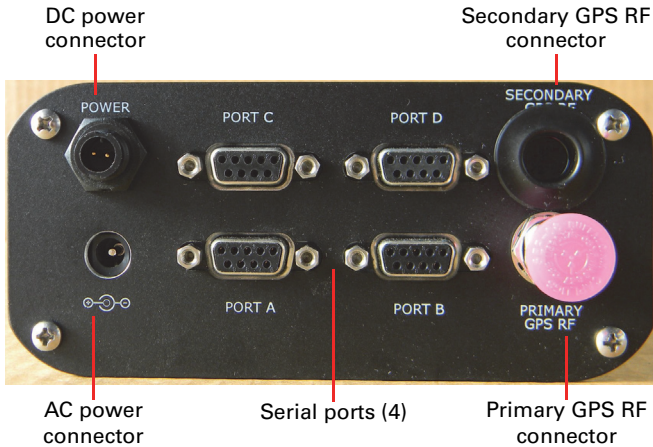

**Figure 2-1: Rear panel connections**

## Routing and Securing the Cables

Consider the following when routing UDK cables:

- Power cable must reach an appropriate power source
- Antenna cable must reach from the antenna to the receiver
- Data cable may connect to a data storage device, computer, or other device that accepts GPS data
- Do not run cables in areas of excessive heat
- Do not expose cables to corrosive chemicals
- Do not crimp or excessively bend cables
- Do not place tension on cables
- Coil up excess cable near unit
- Secure along the cable route using plastic tie wraps as necessary
- Do not run cables near high voltage or strong RF noise and transmitter sources

**WARNING:** Improperly installed cables near machinery can be dangerous.

## Environmental Requirements

The UDK is designed to be stored and operated between -40°C and +85°C (-40°F and +185°F). The optional Hemisphere GPS antennas available for the UDK are designed to operate in an outdoor environment and are waterproof.

*Note: Refer to the OEM board Integrator Guide for environmental requirements for your OEM board.*

## Powering the UDK

The UDK accepts from 5 to 18 VDC and the supplied power should be continuous and clean for best performance. The UDK will start when an acceptable voltage is applied.

---

**⚠ WARNING:** Do not apply a voltage higher than 18 VDC. This will damage the receiver and void the warranty.

---

You can power the UDK in either of the following ways:

- Connect the DC power cable to a suitable power source
  - a. Connect the red wire of the cable's power input to DC positive (+).
  - b. Connect the black wire of the cable's power input to DC negative (-).

*Note: A 1.0 A fast-blow fuse is equipped and situated in-line of the power input of the power cable and protects the UDK from power surges. The fuse container should remain accessible after installation.*

---

**⚠ WARNING:** Do not operate the UDK with the fuse bypassed. This will void the product warranty.

---

- Connect the AC power adapter to the UDK

If the OEM board does not power on, make sure the internal power switch on the carrier board is in the "ON" position (see Figure 2-2).

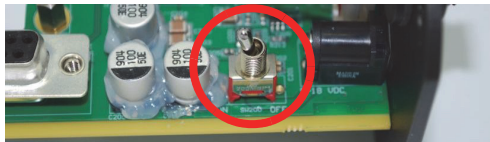

**Figure 2-2: Carrier board ON/OFF switch**

---

**⚠ WARNING:** Connecting more than one source of power at a time can seriously damage the unit and will void the warranty.

---

## Serial Ports

The UDK provides four RS-232 compatible serial ports (located on the rear panel, see Figure 2-1 on page 6) for communicating with external data loggers, navigation systems, PCs, and other devices. The serial ports are labeled Port A, Port B, Port C, and Port D.

Ports A, B and/or C may be used for communication. Port D is designed to communicate with Hemisphere GPS' SBX-4™ DGPS beacon receiver to receive DGPS corrections and only operates at 9600 baud with an 8 data bit, no parity, 1 stop bit configuration (8-N-1). Ports A, B or C may also receive external DGPS or RTK corrections.

*Note: The baud rate of the UDK's serial ports and the devices they are trying to communicate with must match. Refer to your OEM board's documentation to determine the default baud rate of your OEM board. Refer to the Hemisphere GPS Technical Reference (go to [www.hemispheregps.com](http://www.hemispheregps.com) and click the GPS Reference icon) for information on changing baud rates.*

Table 2-1 provides the pin assignments for the serial ports. Refer to your OEM board documentation for communication protocols specific to your OEM board.

**Table 2-1: Serial port pinouts**

Port	Pin	Signal	Description
A,B,C	2	TXD	NMEA 0183, Hemisphere GPS proprietary binary, RTCM v2.3 (DGPS), RTK v3, and CMR output
	3	RXD	NMEA 0183, Hemisphere GPS proprietary binary, RTCM v2.3 (DGPS), RTK v3, CMR, and CMR+ input
	5	Signal ground	Signal return
D	2	TXD	Hemisphere GPS proprietary
	3	RXD	RTCM input
	4	Signal ground	Signal return

Figure 2-3 shows the pinout of each serial port of the UDK.



**Figure 2-3: DB-9 socket numbering**

*Note: Hemisphere GPS OEM boards use a CMOS level interface. The UDK carrier board converts from CMOS to RS-232.*

## USB Ports

The front panel of the UDK has ports for a USB client (device) and a USB host (see Figure 2-5). Refer to your OEM board's documentation for information on USB functionality available for your OEM board.

## LED Indicators

The UDK carrier board features surface-mounted diagnostic LEDs that indicate OEM board status (see Figure 2-4). You can view the LEDs via the front panel of the UDK enclosure, shown in Figure 2-5.

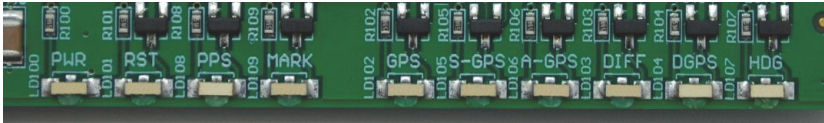

**Figure 2-4: LEDs on the carrier board**



**Figure 2-5: LED indicators on UDK front panel**

Table 2-2 describes the functionality of each LED.

**Table 2-2: LED indicators**

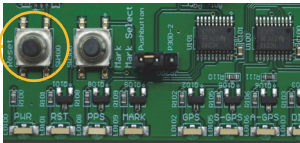
LED	Color	Function	Description
POWER	Red	Power indicator	Illuminates when the OEM board is powered on.
RESET	Green	Reset indicator	<p>Illuminates when you press the Reset button and also flashes on powerup.</p>  <p><i>Note: Since the Reset button is inside the UDK enclosure, use ESD protection when opening the enclosure.</i></p>

**Table 2-2: LED indicators (continued)**

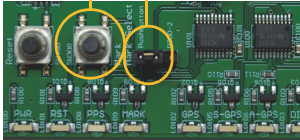
LED	Color	Function	Description
1 PPS	Blue	Timing signal (1 PPS)	Flashes once per second once a GPS signal lock is obtained.
MARK	Red	Mark indicator	<p>Illuminates when you press the Mark button (manual mark). Pins 1 and 2 of JP300 (marked 'Pushbutton') require a jumper to enable the Mark button.</p> <div style="text-align: center;">  <p>Mark button      Pushbutton</p> </div> <p><i>Note: Since the Mark button is inside the UDK enclosure, use ESD protection when opening the enclosure.</i></p>
GPS	Yellow	Primary GPS lock indicator	Illuminates when the OEM board achieves a valid position solution. If this LED continues to flash, it could indicate receiver or antenna hardware failure.
S-GPS	Yellow	Not used (always off)	
A-GPS	Yellow	Not used (always off)	
DIFF	Yellow	Differential lock indicator	<p>Illuminates when the OEM board:</p> <ul style="list-style-type: none"> <li>• Achieves solid SBAS or L-band lock with better than a 150 bit error rate (BER)—if the SBAS BER is higher than 150, but the receiver is still locked, this LED will flash, indicating marginal lock</li> <li>• Receives external DGPS RTCM corrections</li> <li>• Receives L-band DGPS corrections</li> <li>• Receives RTK corrections in any acceptable correction format</li> </ul> <p><i>Note: Not all differential corrections are available on all Hemisphere GPS OEM boards. See your OEM board documentation for details.</i></p>

**Table 2-2: LED indicators (continued)**

LED	Color	Function	Description
DGPS	Green	DGPS position indicator	<p>Illuminates to indicate high accuracy positioning</p> <ul style="list-style-type: none"> <li>• For SBAS, DGPS or L-band DGPS positioning solutions, the LED appears as follows: <ul style="list-style-type: none"> <li>– SOLID if position solution accuracy estimate is below the \$JLIMIT command setting</li> </ul> </li> <li>• For L-band DGPS, L-band high precision, and L-band high precision with GLONASS positioning solutions, the LED appears as follows: <ul style="list-style-type: none"> <li>– SOLID if position accuracy estimate is below the \$JLIMIT command setting, and current GGA message quality indicator is 4 or 5</li> <li>– FLASHES if accuracy is above \$JLIMIT setting, or GGA quality indicator is 2</li> </ul> </li> <li>• For RTK positioning solutions, the LED appears as follows: <ul style="list-style-type: none"> <li>– SOLID if current GGA message quality indicator is 4</li> <li>– FLASHES if current GGA message quality indicator is 2 or 5</li> </ul> </li> </ul> <p><i>Note: Not all differential corrections are available on all Hemisphere GPS OEM boards. Some differential corrections require a paid subscription. An OEM board, such as the LX-2, is required for L-band positioning solutions. A UHF radio is necessary to receive some differential corrections. See your OEM board documentation for details.</i></p>

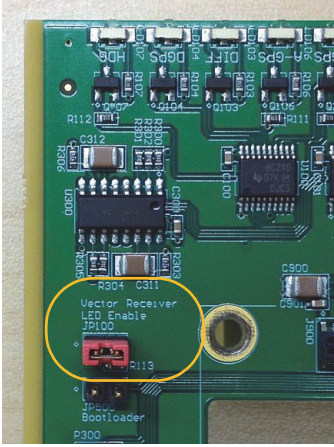

**Table 2-2: LED indicators (continued)**

LED	Color	Function	Description
HDG	Blue	Heading lock indicator	<p>Only in use for Crescent Vector II and Eclipse Vector OEM boards</p> <p>Illuminates continuously when the Crescent Vector II OEM board or Eclipse Vector OEM board has achieved a solid heading lock. Blinking on and off repeatedly may indicate receiver hardware failure.</p> <p><i>Note: You must install a jumper (included in your kit) on JP100 (Vector Receiver LED Enable) to enable heading LED functionality.</i></p> 



## **Chapter 3: Installing an OEM Board**

Using an Adapter Board

Installing Your OEM Board - No Adapter Board Required

Installing Your OEM Board Using Adapter Board A or B

Installing Your OEM Board Using Adapter Board C

Installing Your OEM Board Using Adapter Board D

## Using an Adapter Board

The UDK includes four adapter boards: Boards A, B, C, and D. The UDK also includes two spacer boards (Boards E and F) that are used in conjunction (and only) with Board D.

You can identify the type of adapter board in either of two ways (see Figure 3-1):

- Designation on the board itself ('Board A' or 'Board B' or 'Board C' or 'Board D' is imprinted on the board)
- Number of pins in, and location of, the header connector:
  - Board A has a 34-pin header along the short edge of the board
  - Board B has a 20-pin header along the short edge of the board
  - Boards C and D have a 34-pin header along the long edge of the board

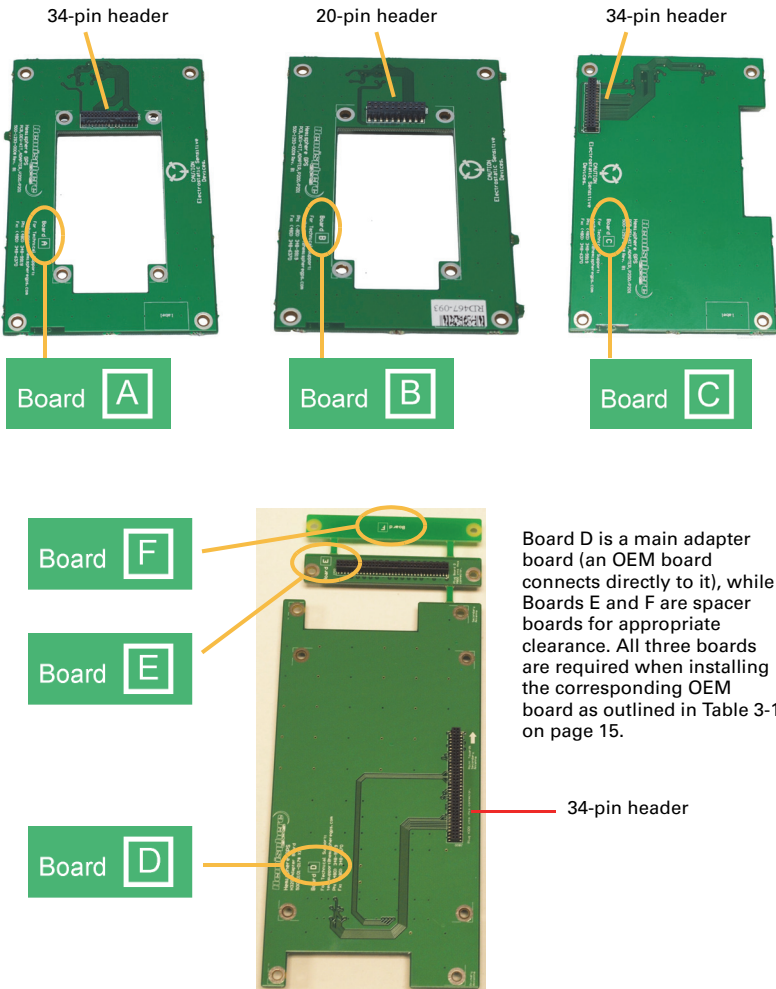

**Figure 3-1: Board A, B, C, and D indicators**

If you are integrating with a large form factor board, such as the Eclipse II, you do not need an adapter board. However, if you are integrating with a small form factor board, such as the Crescent or miniEclipse, use Table 3-1 to determine which adapter board you will need for your OEM board.

**Table 3-1: OEM boards and associated adapter boards**

OEM Board Family	OEM Board Model	Board A	Board B	Board C	Board D
Crescent	P100, P102, P104	X			
Crescent	P101, P103		X		
Crescent Vector II	H101			X	
Eclipse Vector	H200			X	
Eclipse Vector	H320				X
miniEclipse	P200, P202, P300, P302	X			
miniEclipse	P201, P203, P301, P303		X		
LX-2 (requires Crescent or miniEclipse board that uses Board A)	N/A	X			

# Installing Your OEM Board - No Adapter Board Required



**Caution:** Use electrostatic discharge (ESD) protection, such as by wearing an ESD strap that is attached to an earth ground, before handling the UDK or any OEM boards. If an ESD strap is not available touch a metal object prior to handling the UDK or any OEM boards.

Complete the following steps to install your OEM board where no adapter board is required (such as with the Eclipse II board).

1. Unpack your UDK. Refer to “UDK Components” on page 3 for the parts included in your UDK.
2. Remove the four screws from the corners of the rear panel of the enclosure.

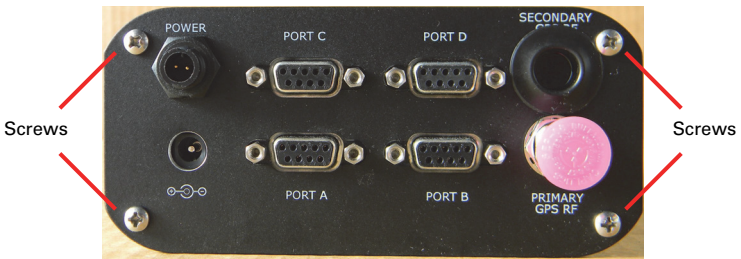

3. Slowly remove the rear panel and attached main carrier board from the enclosure.

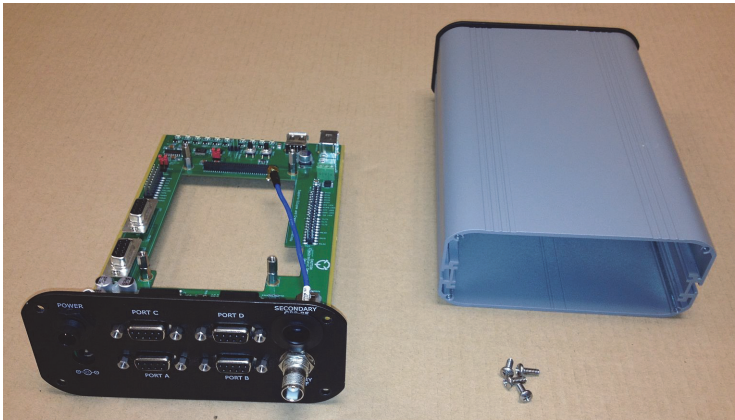

- There are two stacked sets of four standoffs on the main carrier board. Remove the top set of four standoffs and set them aside. You will use them later to secure the OEM board to the carrier board.

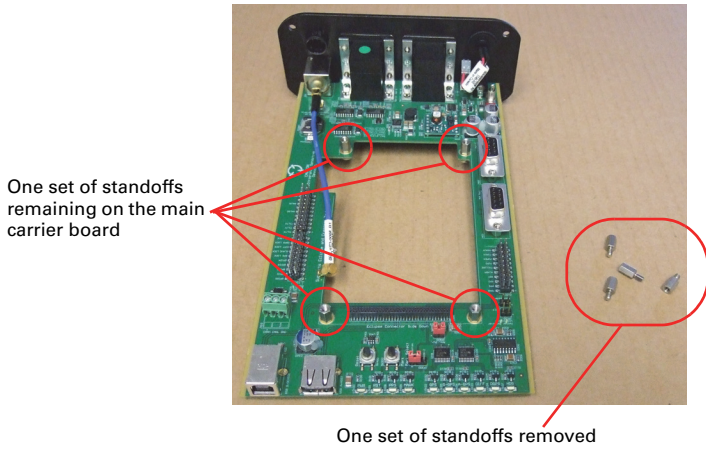

- Connect the free end of the TNC cable to your OEM board (make sure one end is already connected to the main carrier board).

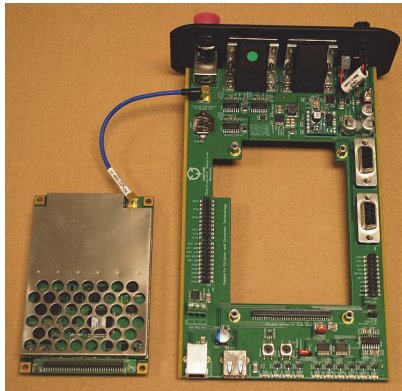

- Place the OEM board on the standoffs so the pin header on the OEM board faces downward and fits into the mating pin header on the main carrier

board, and then attach the standoffs you removed in step 4 to secure the OEM board to the main carrier board (hand-tighten only).

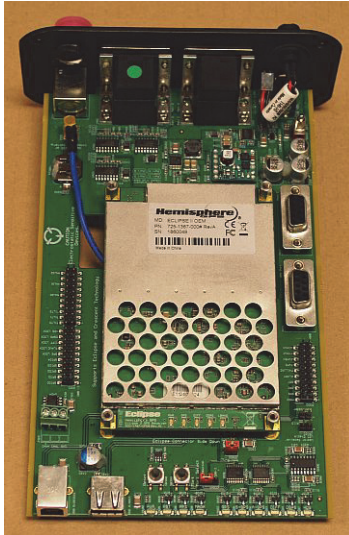

7. Slide the rear panel / main carrier board assembly into the enclosure and use the four screws you removed in step 2 on page 16 to secure the rear panel to the enclosure.



8. Connect an external GPS antenna to the Primary GPS RF port on the rear panel.
9. Connect the serial cable to Port A on the rear panel and to a serial port on your PC.

10. Connect the power cable to a power port on the rear panel and to an external power source. See “Powering the UDK” on page 7 for information on using AC or DC power for the UDK.
11. Power on the UDK.
12. Run PocketMax or SLXMon™ for development and diagnostic testing. PocketMax and SLXMon are Hemisphere GPS products and both are available for download from the Hemisphere GPS website at [www.hemispheregps.com](http://www.hemispheregps.com).



# Installing Your OEM Board Using Adapter Board A or B



**Caution:** Use electrostatic discharge (ESD) protection, such as by wearing an ESD strap that is attached to an earth ground, before handling the UDK or any OEM boards. If an ESD strap is not available touch a metal object prior to handling the UDK or any OEM boards.

*Note: This procedure applies to installing one OEM board or two OEM boards. A two OEM board configuration refers to installing an OEM board with the LX-2 board. Refer to Table 3-1 on page 15 for which OEM boards are compatible with the LX-2 board.*

Complete the following steps to install your OEM board where an adapter board (Board A or B) is required. Refer to Table 3-1 on page 15 to determine the adapter board required for your OEM board.

1. Unpack your UDK. Refer to “UDK Components” on page 3 for the parts included in your UDK.
2. Remove the four screws from the corners of the rear panel of the enclosure.

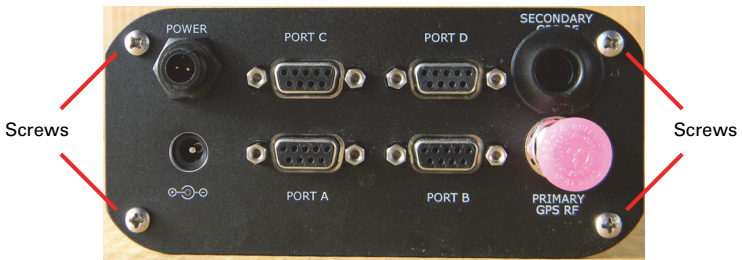

3. Slowly remove the rear panel and attached main carrier board from the enclosure.

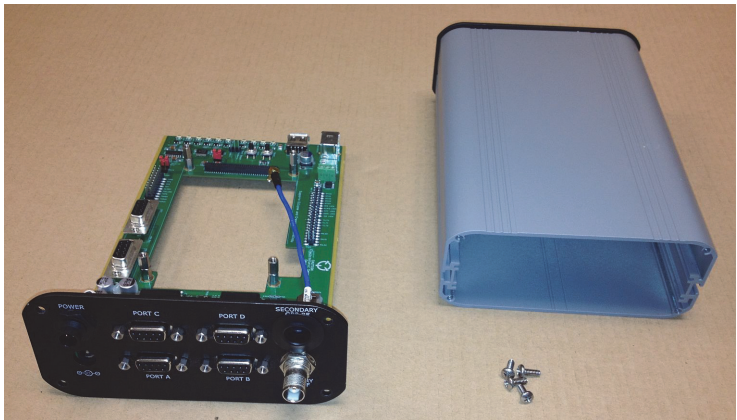

4. There are two stacked sets of four standoffs on the main carrier board. Remove the top set of four standoffs and set them aside. You will use them later to secure the adapter board to the carrier board.

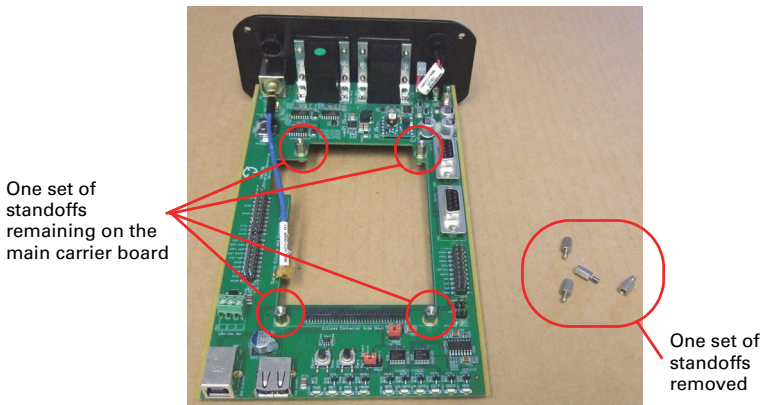

*Note: If you will be installing an LX-2 board, you must install the LX-2 board first and then install the required OEM board on top of it. Proceed to step 5.*

*If you are not installing an LX-2 board, you will only install your OEM board. Proceed to step 6.*

5. Using the nuts, washers, and standoffs from part G (see Table 1-1 on page 3):
  - a. Attach four standoffs to the adapter board, securing them from the underside of the board with the nuts and washers (Figure A below).
  - b. Attach the LX-2 board to the adapter board so the LX-2 board's pin header faces downward and fits into the adapter board's mating pin header and secure the LX-2 board with four standoffs (Figure B below).
  - c. Attach the OEM board to the LX-2 board so the OEM board's pin header faces downward and fits into the LX-2 board's mating pin header and secure the OEM board with four standoffs (Figure C below).

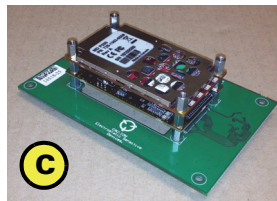
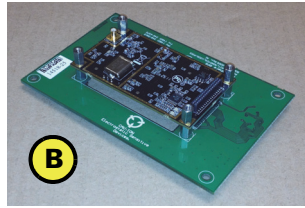
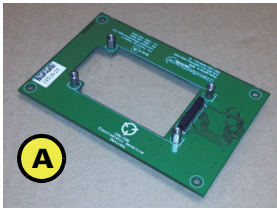

6. Using the nuts, washers, and standoffs from part G (see Table 1-1 on page 3):
  - a. Attach four standoffs to the adapter board, securing them from the underside of the board with the nuts and washers (Figure A below).
  - b. Attach the OEM board to the adapter board so the OEM board's pin header faces downward and fits into the adapter board's mating pin header and secure the OEM board with four standoffs (Figure B below).

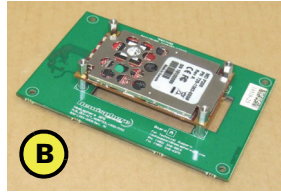
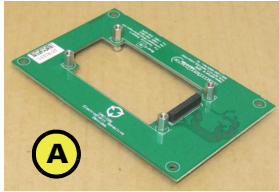

7. Connect the free end of the TNC cable to your OEM board (make sure one end is already connected to the main carrier board).

*Note: If you installed the LX-2 board in step 5, you will connect the free end of the TNC cable to the LX-2 board.*

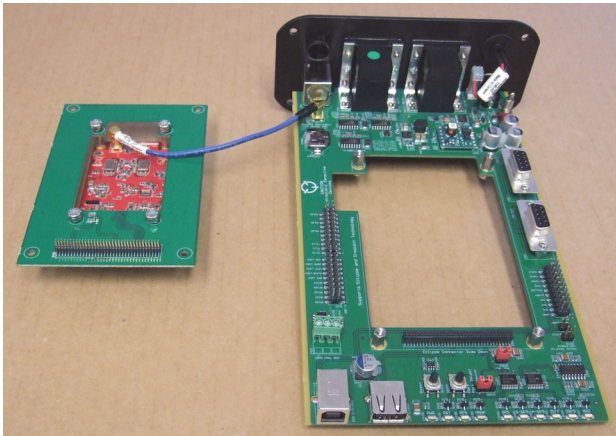

8. Place the adapter board on the standoffs so the adapter board's pin header faces downward and fits into the main carrier board's mating pin header, and

then attach the standoffs you removed in step 4 to secure the adapter board to the main carrier board (hand-tighten only).

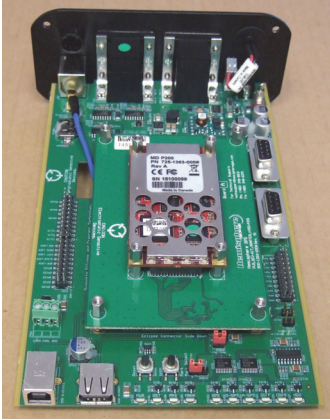

One OEM board attached to adapter board

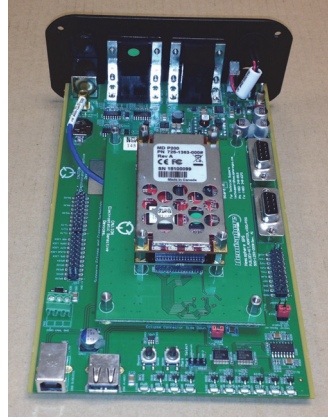

Two OEM boards attached to adapter board

9. Slide the rear panel / main carrier board assembly into the enclosure and use the four screws you removed in step 2 on page 20 to secure the rear panel to the enclosure.



10. Connect an external GPS antenna to the Primary GPS RF port on the rear panel.
11. Connect the serial cable to Port A on the rear panel and to a serial port on your PC.
12. Connect the power cable to a power port on the rear panel and to an external power source. See “Powering the UDK” on page 7 for information on using AC or DC power for the UDK.

13. Power on the UDK.
14. Run PocketMax or SLXMon for development and diagnostic testing. PocketMax and SLXMon are Hemisphere GPS products and both are available for download from the Hemisphere GPS website at [www.hemispheregps.com](http://www.hemispheregps.com).

## Installing Your OEM Board Using Adapter Board C



**Caution:** Use electrostatic discharge (ESD) protection, such as by wearing an ESD strap that is attached to an earth ground, before handling the UDK or any OEM boards. If an ESD strap is not available touch a metal object prior to handling the UDK or any OEM boards.

Complete the following steps to install your OEM board where adapter board C is required.

1. Unpack your UDK. Refer to “UDK Components” on page 3 for the parts included in your UDK.
2. Remove the four screws from the corners of the rear panel of the enclosure.

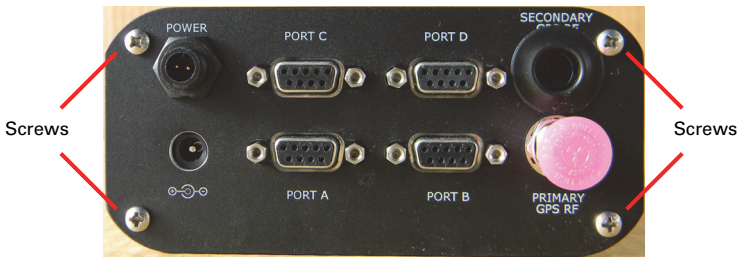

3. Slowly remove the rear panel and attached main carrier board from the enclosure.

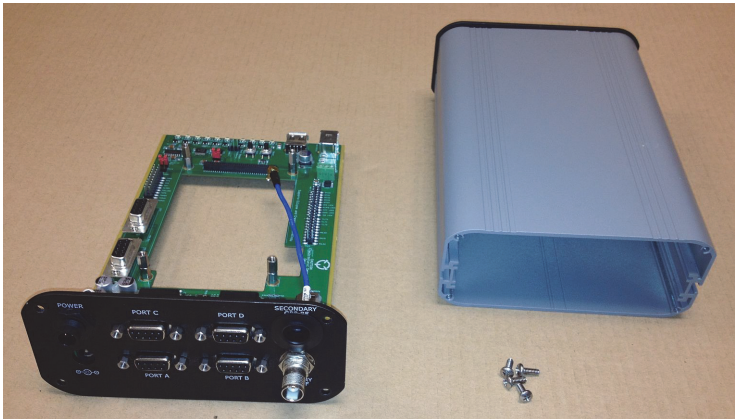

- There are two stacked sets of four standoffs on the main carrier board. Remove the top set of four standoffs and set them aside. You will use them later to secure the adapter board to the carrier board.

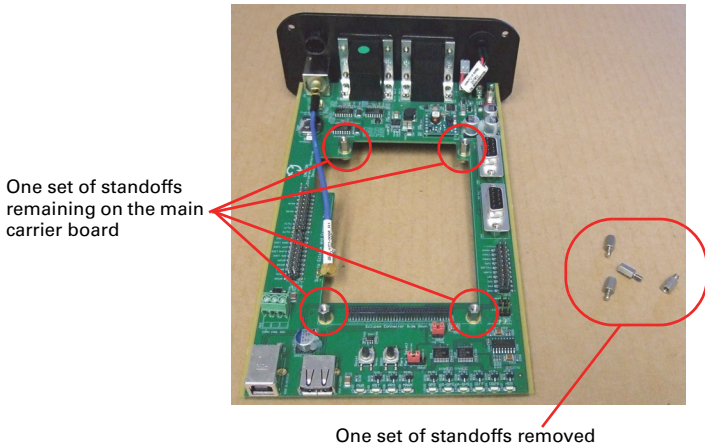

- Remove the rubber grommet from the Secondary GPS RF port on the rear panel of the enclosure and then attach the standalone RF connector (Part F in Table 1-1 on page 3) to the Secondary port opening.

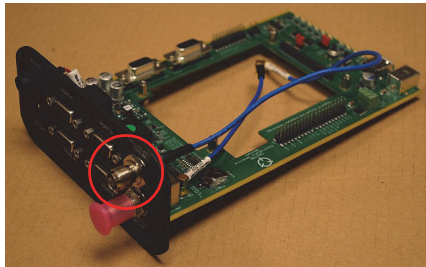

- Place the adapter board on the standoffs so the adapter board's pin header faces downward and fits into the main carrier board's mating pin header, and then attach the standoffs you removed in step 4 to secure the adapter board to the main carrier board (hand-tighten only).

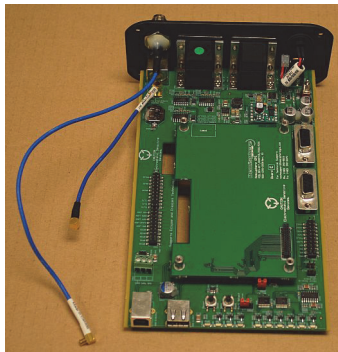

7. Connect the free end of each TNC cable to your OEM board as shown below.

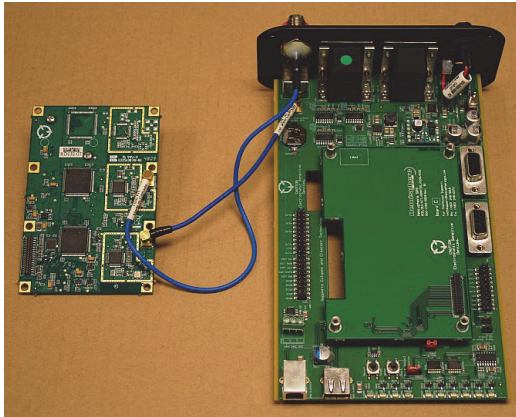

8. Attach the OEM board to the adapter board so the OEM board's pin header faces downward and fits into the adapter board's mating pin header, and then using standoffs from part G (see Table 1-1 on page 3) secure the OEM board to the standoffs (hand-tighten only).

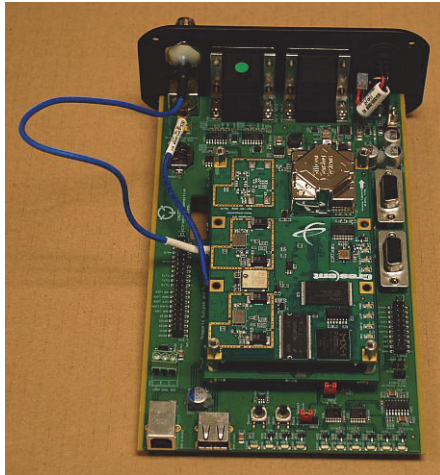



9. Slide the rear panel / main carrier board assembly into the enclosure and use the four screws you removed in step 2 on page 25 to secure the rear panel to the enclosure.



10. Connect two external GPS antennas to the rear panel of the UDK: one to the Primary GPS RF port and the other to the Secondary GPS RF port.
11. Connect the serial cable to Port A on the rear panel and to a serial port on your PC.
12. Connect the power cable to a power port on the rear panel and to an external power source. See "Powering the UDK" on page 7 for information on using AC or DC power for the UDK.
13. Power on the UDK.
14. Run PocketMax or SLXMon for development and diagnostic testing. PocketMax and SLXMon are Hemisphere GPS products and both are available for download from the Hemisphere GPS website at [www.hemispheregps.com](http://www.hemispheregps.com).

## Installing Your OEM Board Using Adapter Board D



**Caution:** Use electrostatic discharge (ESD) protection, such as by wearing an ESD strap that is attached to an earth ground, before handling the UDK or any OEM boards. If an ESD strap is not available touch a metal object prior to handling the UDK or any OEM boards.

Complete the following steps to install your OEM board where adapter board D is required.

1. Unpack your UDK. Refer to “UDK Components” on page 3 for the parts included in your UDK.
2. Remove the four screws from the corners of the rear panel of the enclosure.

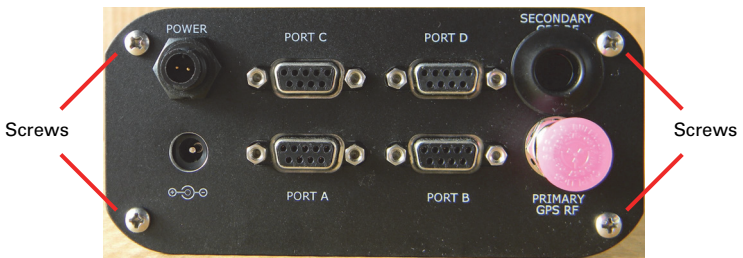

3. Slowly remove the rear panel and attached main carrier board from the enclosure.

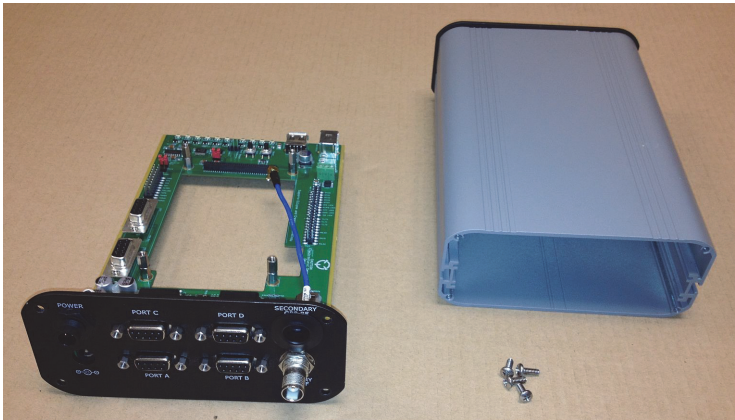

4. There are two stacked sets of four standoffs on the main carrier board. Remove the top set of four standoffs and set them aside. You will use them later to secure the adapter board to the carrier board.

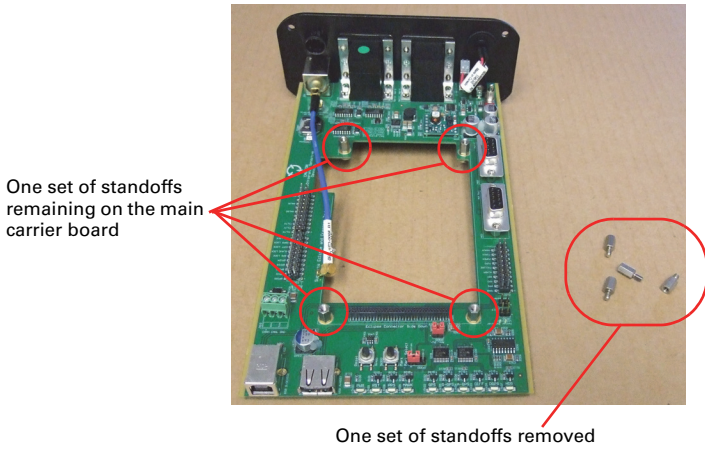

5. Remove the rubber grommet from the Secondary GPS RF port on the rear panel of the enclosure and then attach the standalone RF connector (Part F in Table 1-1 on page 3) to the Secondary port opening.

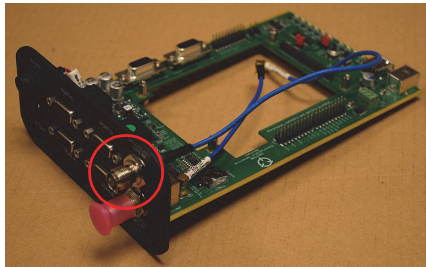

6. Attach adapter boards D, E, and F:
  - a. Place adapter board E on the standoffs near the carrier board's header so the adapter board's pin header faces downward and fits into the main carrier board's mating pin header.
  - b. Place adapter board F on the other two standoffs.
  - c. Attach the standoffs you removed in step 4 to secure adapter boards E and F to the main carrier board (hand-tighten only).

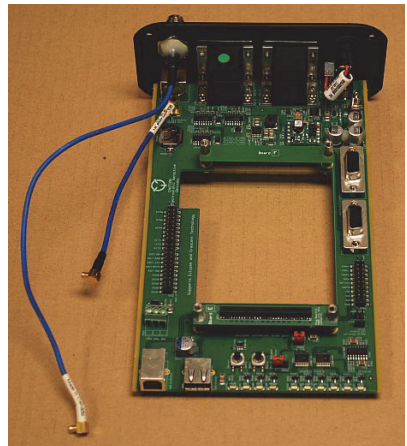

- d. Attach four standoffs and screws from part G (see Table 1-1 on page 3) to the four outer holes of adapter board D. Make sure the standoffs are on the side of the board with the connector (J800) on the long side of the board.

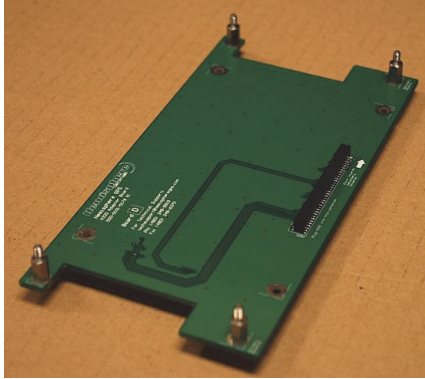

- e. Place adapter board D on the standoffs above adapter boards E and F so adapter board D's pin header faces downward and fits into adapter board E's mating pin header, and then secure adapter board D with four nuts and four washers from part G (see Table 1-1 on page 3).

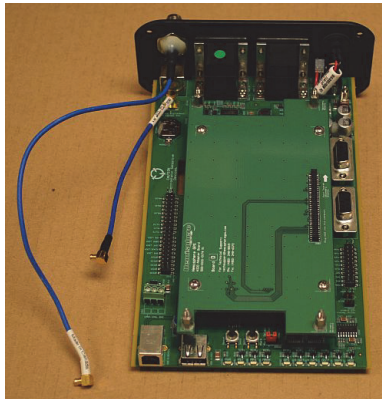

7. Connect the free end of each TNC cable to your OEM board as shown below.

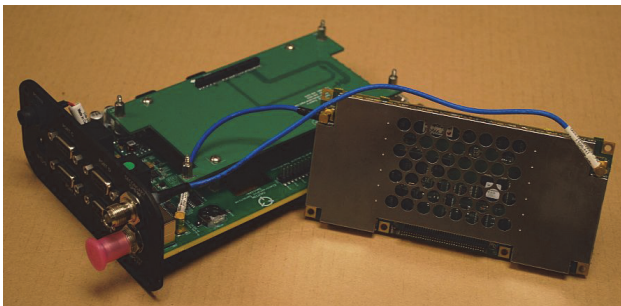

8. Attach the OEM board to the adapter board so the OEM board's pin header faces downward and fits into the adapter board's mating pin header, and then using the nuts from part G (see Table 1-1 on page 3) secure the OEM board to the standoffs.

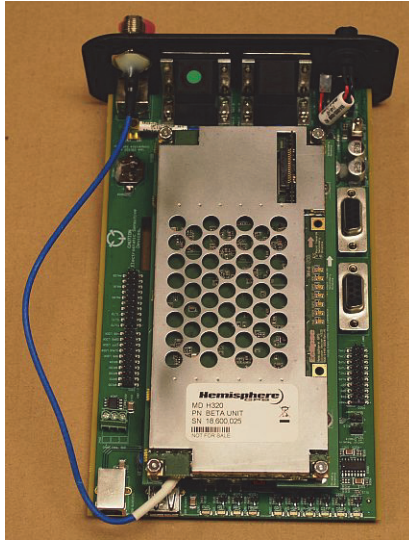

9. Slide the rear panel / main carrier board assembly into the enclosure and use the four screws you removed in step 2 on page 29 to secure the rear panel to the enclosure.

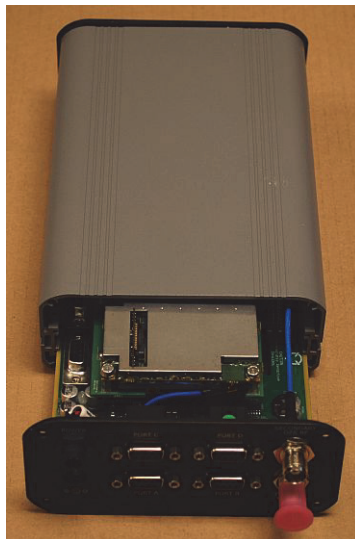

10. Connect two external GPS antennas to the rear panel of the UDK: one to the Primary GPS RF port and the other to the Secondary GPS RF port.

11. Connect the serial cable to Port A on the rear panel and to a serial port on your PC.
12. Connect the power cable to a power port on the rear panel and to an external power source. See “Powering the UDK” on page 7 for information on using AC or DC power for the UDK.
13. Power on the UDK.
14. Run PocketMax or SLXMon for development and diagnostic testing. PocketMax and SLXMon are Hemisphere GPS products and both are available for download from the Hemisphere GPS website at [www.hemispheregps.com](http://www.hemispheregps.com).



---

# Index

---

## Numerics

1 PPS LED 10

## A

AC power adapter 4, 7  
adapter boards  
    associated OEM boards 15  
    Boards A, B, C, and D 14  
    using 14  
A-GPS LED 10

## B

Board A 3, 14  
Board B 3, 14  
Board C 3, 14  
Board D 3, 14  
board integration 4

## C

cables  
    interface 6  
    routing and securing 6  
carrier board 2, 3  
    LED indicators 9  
    ON/OFF switch 7  
Crescent OEM board 2, 15, 20  
Crescent Vector II OEM board 2, 4, 6,  
12, 15

## D

DC power cable 3, 7  
development kit, See Universal Development Kit  
DGPS LED 11  
Diff LED 10

## E

Eclipse II OEM board 15, 16  
Eclipse Vector OEM board 2, 15  
environmental requirements 7

## G

GPS LED 10

## H

HDG LED 12

## I

installing  
    OEM with adapter board A or B  
        20  
    OEM with adapter board C 25  
    OEM with adapter board D 29  
    OEM with no adapter board 16  
integration 4

## L

LED indicators 9  
    1 PPS 10  
    A-GPS 10  
    DGPS 11  
    Diff 10  
    GPS 10  
    HDG 12  
    MARK 10  
    POWER 9  
    RESET 9  
    S-GPS 10  
    UDK 9  
LX-2 OEM board 15, 20, 21, 22

## M

MARK LED 10  
miniEclipse OEM board 15, 20

## O

OEM boards  
    associated adapter boards 15  
    Crescent 2, 15, 20  
    Crescent Vector II 2, 4, 6, 12, 15  
    Eclipse II 15, 16  
    Eclipse Vector 2, 15  
    installing with adapter board A or  
        B 20  
    installing with adapter board C  
        25  
    installing with adapter board D  
        29  
    installing with no adapter board  
        16  
    integration 4  
    LX-2 15, 20, 21, 22  
    miniEclipse 15, 20  
    supported by Universal Development Kit 2



- supporting documentation 2
- ON/OFF switch 7

## **P**

ports

- development kit 8

- Port A 8

- Port B 8

- Port C 8

- Port D 8

- POWER LED 9

## **R**

- RESET LED 9

- routing cables 6

## **S**

- securing cables 6

- serial ports 8

- Port A 8

- Port B 8

- Port C 8

- Port D 8

- S-GPS LED 10

- supported OEM boards 2

- supporting OEM board documenta-  
tion 2

## **U**

- UDK, See Universal Development Kit

- Universal Development Kit

- cable interface 6

- environmental requirements 7

- LED indicators 9

- routing and securing cables 6

- serial ports 8

- supported OEM board 2

- supporting documentation 2

- USB ports 9

- what is it 2

- USB ports 9

# End User License Agreement

**IMPORTANT** - This is an agreement (the "**Agreement**") between you, the end purchaser ("**Licensee**") and Hemisphere GPS Inc. ("**Hemisphere**") which permits Licensee to use the Hemisphere software (the "**Software**") that accompanies this Agreement. This Software may be licensed on a standalone basis or may be embedded in a Product. Please read and ensure that you understand this Agreement before installing or using the Software Update or using a Product.

In this agreement any product that has Software embedded in it at the time of sale to the Licensee shall be referred to as a "**Product**". As well, in this Agreement, the use of a Product shall be deemed to be use of the Software which is embedded in the Product.

BY INSTALLING OR USING THE SOFTWARE UPDATE OR THE PRODUCT, LICENSEE THEREBY AGREES TO BE LEGALLY BOUND BY THE TERMS OF THIS AGREEMENT. IF YOU DO NOT AGREE TO THESE TERMS, (I) DO NOT INSTALL OR USE THE SOFTWARE, AND (II) IF YOU ARE INSTALLING AN UPDATE TO THE SOFTWARE, DO NOT INSTALL THE UPDATE AND PROMPTLY DESTROY IT.

HEMISPHERE PROVIDES LIMITED WARRANTIES IN RELATION TO THE SOFTWARE. AS WELL, THOSE WHO USE THE EMBEDDED SOFTWARE DO SO AT THEIR OWN RISK. YOU SHOULD UNDERSTAND THE IMPORTANCE OF THESE AND OTHER LIMITATIONS SET OUT IN THIS AGREEMENT BEFORE INSTALLING OR USING THE SOFTWARE OR THE PRODUCT.

1. **LICENSE.** Hemisphere hereby grants to Licensee a non-transferable and non-exclusive license to use the Software as embedded in a Product and all Updates (collectively the "**Software**"), solely in binary executable form.
2. **RESTRICTIONS ON USE.** Licensee agrees that Licensee and its employees will not directly or indirectly, in any manner whatsoever:
  - a. install or use more copies of the Software than the number of copies that have been licensed;
  - b. use or install the Software in connection with any product other than the Product the Software was intended to be used or installed on as set out in the documentation that accompanies the Software.
  - c. copy any of the Software or any written materials for any purpose except as part of Licensee's normal backup processes;
  - d. modify or create derivative works based on the Software;
  - e. sub-license, rent, lease, loan or distribute the Software;
  - f. permit any third party to use the Software;
  - g. use or operate Product for the benefit of any third party in any type of service outsourcing, application service, provider service or service bureau capacity;
  - h. reverse engineer, decompile or disassemble the Software or otherwise reduce it to a human perceivable form;
3. **UPDATES.** At Hemisphere's discretion Hemisphere may make Updates available to Licensee. An update ("**Update**") means any update to the Software that is made available to Licensee including error corrections, enhancements and other modifications. Licensee may access, download and install Updates during the Warranty Period only. All Updates that Licensee downloads, installs or uses shall be deemed to be Software and subject to this Agreement. Hemisphere reserves the right to modify the Product without any obligation to notify, supply or install any improvements or alterations to existing Software.
4. **SUPPORT.** Hemisphere may make available directly or through its authorized dealers telephone and email support for the Software. Contact Hemisphere to find the authorized dealer near you. As well, Hemisphere may make available user and technical documentation regarding the Software. Hemisphere reserves the right to reduce and limit access to such support at any time.
5. **BACKUPS AND RECOVERY.** Licensee shall back-up all data used, created or stored by the Software on a regular basis as necessary to enable proper recovery of the data and related systems and processes in the event of a malfunction in the Software or any loss or corruption of data caused by the Software. Licensee shall assume all risks of loss or damage for any failure to comply with the foregoing.
6. **OWNERSHIP.** Hemisphere and its suppliers own all rights, title and interest in and to the Software and related materials, including all intellectual property rights. The Software is licensed to Licensee, not sold.
7. **TRADEMARKS.** "Hemisphere GPS", "Outback Guidance", "BEELINE", "Crescent", "Eclipse" and the associated logos are trademarks of Hemisphere. Other trademarks are the property of their respective owners. Licensee may not use any of these trademarks without the consent of their respective owners.
8. **LIMITED WARRANTY.** Hemisphere warrants solely to the Licensee, subject to the exclusions and procedures set forth herein below, that for a period of one (1) year from the original date of purchase of the Product in which it is embedded (the "Warranty Period"), the Software, under normal use and maintenance, will conform in all material respects to the documentation provided with the Software and any media will be free of defects in materials and workmanship. For any Update, Hemisphere warrants, for 90 days from performance or delivery, or for the balance of the original Warranty Period, whichever is greater, that the Update, under normal use and maintenance, will conform in all material respects to the documentation provided with the Update and any media will be free of defects in materials and workmanship. Notwithstanding the foregoing, Hemisphere does not warrant that the Software will meet Licensee's requirements or that its operation will be error free.
9. **WARRANTY EXCLUSIONS.** The warranty set forth in Section (8) will not apply to any deficiencies caused by (a) the Product not being used as described in the documentation supplied to Licensee, (b) the Software having been altered, modified or converted in any way by anyone other than Hemisphere approved by Hemisphere, (c) any malfunction of Licensee's equipment or other software, or (d) damage occurring in transit or due to any accident, abuse, misuse, improper installation, lightning (or other electrical discharge) or neglect other than that caused by Hemisphere. Hemisphere GPS does not warrant or guarantee the precision or accuracy of positions obtained when using the Software (whether standalone or embedded in a Product). The Product and the Software is not intended and should not be used as the primary means of navigation or for use in safety of life applications. The potential

positioning and navigation accuracy obtainable with the Software as stated in the Product or Software documentation serves to provide only an estimate of achievable accuracy based on specifications provided by the US Department of Defense for GPS positioning and DGPS service provider performance specifications, where applicable.

10. **WARRANTY DISCLAIMER.** EXCEPT AS EXPRESSLY SET OUT IN THIS AGREEMENT, HEMISPHERE MAKES NO REPRESENTATION, WARRANTY OR CONDITION OF ANY KIND TO LICENSEE, WHETHER VERBAL OR WRITTEN AND HEREBY DISCLAIMS ALL REPRESENTATIONS, WARRANTIES AND CONDITIONS OF ANY KIND INCLUDING FITNESS FOR A PARTICULAR PURPOSE, MERCHANTABILITY, ACCURACY, RELIABILITY OR THAT THE USE OF THE SOFTWARE WILL BE UNINTERRUPTED OR ERROR-FREE AND HEREBY DISCLAIMS ALL REPRESENTATIONS, WARRANTIES AND CONDITIONS ARISING AS A RESULT OF CUSTOM, USAGE OR TRADE AND THOSE ARISING UNDER STATUTE.
11. **LIMITS ON WARRANTY DISCLAIMER.** Some jurisdictions do not allow the exclusion of implied warranties or conditions, so some of the above exclusions may not apply to Licensee. In that case, any implied warranties or conditions which would then otherwise arise will be limited in duration to ninety (90) days from the date of the license of the Software or the purchase of the Product. The warranties given herein give Licensee specific legal rights and Licensee may have other rights which may vary from jurisdiction to jurisdiction.
12. **CHANGE TO WARRANTY.** No employee or agent of Hemisphere is authorized to change the warranty provided or the limitation or disclaimer of warranty provisions. All such changes will only be effective if pursuant to a separate agreement signed by senior officers of the respective parties.
13. **WARRANTY CLAIM.** In the event Licensee has a warranty claim Licensee must first check for and install all Updates that are made available. The warranty will not otherwise be honored. Proof of purchase may be required. Hemisphere does not honor claims asserted after the end of the Warranty Period.
14. **LICENSEE REMEDIES.** In all cases which involve a failure of the Software to conform in any material respect to the documentation during the Warranty Period or a breach of a warranty, Hemisphere's sole obligation and liability, and Licensee's sole and exclusive remedy, is for Hemisphere, at Hemisphere's option, to (a) repair the Software, (b) replace the Software with software conforming to the documentation, or (c) if Hemisphere is unable, on a reasonable commercial basis, to repair the Software or to replace the Software with conforming software within ninety (90) days, to terminate this Agreement and thereafter Licensee shall cease using the Software. Hemisphere will also issue a refund for the price paid by Licensee less an amount on account of amortization, calculated on a straight-line basis over a deemed useful life of three (3) years.
15. **LIMITATION OF LIABILITY.** IN NO EVENT WILL HEMISPHERE BE LIABLE TO LICENSEE FOR ANY INCIDENTAL, CONSEQUENTIAL, SPECIAL OR INDIRECT DAMAGES INCLUDING ARISING IN RELATION TO ANY LOSS OF DATA, INCOME, REVENUE, GOODWILL OR ANTICIPATED SAVINGS EVEN IF HEMISPHERE HAS BEEN INFORMED OF THE POSSIBILITY OF SUCH LOSS OR DAMAGE. FURTHER, IN NO EVENT WILL HEMISPHERE'S TOTAL CUMULATIVE LIABILITY HEREUNDER, FROM ALL CAUSES OF ACTION OF ANY KIND, EXCEED THE TOTAL AMOUNT PAID BY LICENSEE TO HEMISPHERE TO PURCHASE THE PRODUCT. THIS LIMITATION AND EXCLUSION APPLIES IRRESPECTIVE OF THE CAUSE OF ACTION, INCLUDING BUT NOT LIMITED TO BREACH OF CONTRACT, NEGLIGENCE, STRICT LIABILITY, TORT, BREACH OF WARRANTY, MISREPRESENTATION OR ANY OTHER LEGAL THEORY AND WILL SURVIVE A FUNDAMENTAL BREACH.
16. **LIMITS ON LIMITATION OF LIABILITY.** Some jurisdictions do not allow for the limitation or exclusion of liability for incidental or consequential damages, so the above limitation or exclusion may not apply to Licensee and Licensee may also have other legal rights which may vary from jurisdiction to jurisdiction.
17. **BASIS OF BARGAIN.** Licensee agrees and acknowledges that Hemisphere has set its prices and the parties have entered into this Agreement in reliance on the limited warranties, warranty disclaimers and limitations of liability set forth herein, that the same reflect an agreed-to allocation of risk between the parties (including the risk that a remedy may fail of its essential purpose and cause consequential loss), and that the same forms an essential basis of the bargain between the parties. Licensee agrees and acknowledges that Hemisphere would not have been able to sell the Product at the amount charged on an economic basis without such limitations.
18. **PROPRIETARY RIGHTS INDEMNITY.** Hemisphere shall indemnify, defend and hold harmless Licensee from and against any and all actions, claims, demands, proceedings, liabilities, direct damages, judgments, settlements, fines, penalties, costs and expenses, including royalties and attorneys' fees and related costs, in connection with or arising out of any actual infringement of any third party patent, copyright or other intellectual property right by the Software or by its use, in accordance with this Agreement and documentation, PROVIDED THAT: (a) Hemisphere has the right to assume full control over any action, claim, demand or proceeding, (b) Licensee shall promptly notify Hemisphere of any such action, claim, demand, or proceeding, and (c) Licensee shall give Hemisphere such reasonable assistance and tangible material as is reasonably available to Licensee for the defense of the action, claim, demand or proceeding. Licensee shall not settle or compromise any of same for which Hemisphere has agreed to assume responsibility without Hemisphere's prior written consent. Licensee may, at its sole cost and expense, retain separate counsel from the counsel utilized or retained by Hemisphere.
19. **INFRINGEMENT.** If use of the Software may be enjoined due to a claim of infringement by a third party then, at its sole discretion and expense, Hemisphere may do one of the following: (a) negotiate a license or other agreement so that the Product is no longer subject to such a potential claim, (b) modify the Product so that it becomes non-infringing, provided such modification can be accomplished without materially affecting the performance and functionality of the Product, (c) replace the Software, or the Product, with non-infringing software, or product, of equal or better performance and quality, or (d) if none of the foregoing can be done on a commercially reasonable basis, terminate this license and Licensee shall stop using the Product and Hemisphere shall refund the price paid by Licensee less an amount on account of amortization, calculated on a straight-line basis over a deemed useful life of three (3) years.  
The foregoing sets out the entire liability of Hemisphere and the sole obligations of Hemisphere to Licensee in respect of any claim that the Software or its use infringes any third party rights.
20. **INDEMNIFICATION.** Except in relation to an infringement action, Licensee shall indemnify and hold Hemisphere harmless from any and all claims, damages, losses, liabilities, costs and expenses (including reasonable fees of lawyers and other professionals) arising out of or in connection with Licensee's use of the Product, whether direct or indirect, including without limiting the foregoing, loss of data, loss of profit or business interruption.

21. **TERMINATION.** Licensee may terminate this Agreement at any time without cause. Hemisphere may terminate this Agreement on 30 days notice to Licensee if Licensee fails to materially comply with each provision of this Agreement unless such default is cured within the 30 days. Any such termination by a party shall be in addition to and without prejudice to such rights and remedies as may be available, including injunction and other equitable remedies. Upon receipt by Licensee of written notice of termination from Hemisphere or termination by Licensee, Licensee shall at the end of any notice period (a) cease using the Software; and (b) return to Hemisphere (or destroy and provide a certificate of a Senior Officer attesting to such destruction) the Software and all related material and any magnetic or optical media provided to Licensee. The provisions of Sections 6), 7), 8), 9), 10), 15), 21), 26) and 27) herein shall survive the expiration or termination of this Agreement for any reason.
22. **EXPORT RESTRICTIONS.** Licensee agrees that Licensee will comply with all export control legislation of Canada, the United States, Australia and any other applicable country's laws and regulations, whether under the Arms Export Control Act, the International Traffic in Arms Regulations, the Export Administration Regulations, the regulations of the United States Departments of Commerce, State, and Treasury, or otherwise as well as the export control legislation of all other countries.
23. **PRODUCT COMPONENTS.** The Product may contain third party components. Those third party components may be subject to additional terms and conditions. Licensee is required to agree to those terms and conditions in order to use the Product.
24. **FORCE MAJEURE EVENT.** Neither party will have the right to claim damages as a result of the other's inability to perform or any delay in performance due to unforeseeable circumstances beyond its reasonable control, such as labor disputes, strikes, lockouts, war, riot, insurrection, epidemic, Internet virus attack, Internet failure, supplier failure, act of God, or governmental action not the fault of the non-performing party.
25. **FORUM FOR DISPUTES.** The parties agree that the courts located in Calgary, Alberta, Canada and the courts of appeal there from will have exclusive jurisdiction to resolve any disputes between Licensee and Hemisphere concerning this Agreement or Licensee's use or inability to use the Software and the parties hereby irrevocably agree to attorn to the jurisdiction of those courts. Notwithstanding the foregoing, either party may apply to any court of competent jurisdiction for injunctive relief.
26. **APPLICABLE LAW.** This Agreement shall be governed by the laws of the Province of Alberta, Canada, exclusive of any of its choice of law and conflicts of law jurisprudence.
27. **CISG.** The United Nations Convention on Contracts for the International Sale of Goods will not apply to this Agreement or any transaction hereunder.
28. **GENERAL.** This is the entire agreement between Licensee and Hemisphere relating to the Product and Licensee's use of the same, and supersedes all prior, collateral or contemporaneous oral or written representations, warranties or agreements regarding the same. No amendment to or modification of this Agreement will be binding unless in writing and signed by duly authorized representatives of the parties. Any and all terms and conditions set out in any correspondence between the parties or set out in a purchase order which are different from or in addition to the terms and conditions set forth herein, shall have no application and no written notice of same shall be required. In the event that one or more of the provisions of this Agreement is found to be illegal or unenforceable, this Agreement shall not be rendered inoperative but the remaining provisions shall continue in full force and effect.

# Warranty Notice

**COVERED PRODUCTS:** This warranty covers all products manufactured by Hemisphere GNSS and purchased by the end purchaser (the "Products"), unless otherwise specifically and expressly agreed in writing by Hemisphere GNSS.

**LIMITED WARRANTY:** Hemisphere GNSS warrants solely to the end purchaser of the Products, subject to the exclusions and procedures set forth below, that the Products sold to such end purchaser and its internal components shall be free, under normal use and maintenance, from defects in materials, and workmanship and will substantially conform to Hemisphere GNSS' applicable specifications for the Product, for a period of 12 months from delivery of such Product to such end purchaser (the "Warranty Period"). Repairs and replacement components for the Products are warranted, subject to the exclusions and procedures set forth below, to be free, under normal use and maintenance, from defects in material and workmanship, and will substantially conform to Hemisphere GNSS' applicable specifications for the Product, for 90 days from performance or delivery, or for the balance of the original Warranty Period, whichever is greater.

**EXCLUSION OF ALL OTHER WARRANTIES.** The LIMITED WARRANTY shall apply only if the Product is properly and correctly installed, configured, interfaced, maintained, stored, and operated in accordance with Hemisphere GNSS' relevant User's Manual and Specifications, AND the Product is not modified or misused. The Product is provided "AS IS" and the implied warranties of MERCHANTABILITY and FITNESS FOR A PARTICULAR PURPOSE and ALL OTHER WARRANTIES, express, implied or arising by statute, by course of dealing or by trade usage, in connection with the design, sale, installation, service or use of any products or any component thereof, are EXCLUDED from this transaction and shall not apply to the Product. The LIMITED WARRANTY is IN LIEU OF any other warranty, express or implied, including but not limited to, any warranty of MERCHANTABILITY or FITNESS FOR A PARTICULAR PURPOSE, title, and non-infringement.

**LIMITATION OF REMEDIES.** The purchaser's EXCLUSIVE REMEDY against Hemisphere GNSS shall be, at Hemisphere GNSS' option, the repair or replacement of any defective Product or components thereof. The purchaser shall notify Hemisphere GNSS or a Hemisphere GNSS' approved service center immediately of any defect. Repairs shall be made through a Hemisphere GNSS approved service center only. Repair, modification or service of Hemisphere GNSS products by any party other than a Hemisphere GNSS approved service center shall render this warranty null and void. The remedy in this paragraph shall only be applied in the event that the Product is properly and correctly installed, configured, interfaced, maintained, stored, and operated in accordance with Hemisphere GNSS' relevant User's Manual and Specifications, AND the Product is not modified or misused. NO OTHER REMEDY (INCLUDING, BUT NOT LIMITED TO, SPECIAL, INDIRECT, INCIDENTAL, CONSEQUENTIAL OR CONTINGENT DAMAGES FOR LOST PROFITS, LOST SALES, INJURY TO PERSON OR PROPERTY, OR ANY OTHER INCIDENTAL OR CONSEQUENTIAL LOSS) SHALL BE AVAILABLE TO PURCHASER, even if Hemisphere GNSS has been advised of the possibility of such damages. Without limiting the foregoing, Hemisphere GNSS shall not be liable for any damages of any kind resulting from installation, use, quality, performance or accuracy of any Product.

**HEMISPHERE IS NOT RESPONSIBLE FOR PURCHASER'S NEGLIGENCE OR UNAUTHORIZED USES OF THE PRODUCT.** IN NO EVENT SHALL HEMISPHERE GNSS BE IN ANY WAY RESPONSIBLE FOR ANY DAMAGES RESULTING FROM PURCHASER'S OWN NEGLIGENCE, OR FROM OPERATION OF THE PRODUCT IN ANY WAY OTHER THAN AS SPECIFIED IN HEMISPHERE GNSS' RELEVANT USER'S MANUAL AND SPECIFICATIONS. Hemisphere GNSS is NOT RESPONSIBLE for defects or performance problems resulting from (1) misuse, abuse, improper installation, neglect of Product; (2) the utilization of the Product with hardware or software products, information, data, systems, interfaces or devices not made, supplied or specified by Hemisphere GNSS; (3) the operation of the Product under any specification other than, or in addition to, the specifications set forth in Hemisphere GNSS' relevant User's Manual and Specifications; (4) damage caused by accident or natural events, such as lightning (or other electrical discharge) or fresh/salt water immersion of Product; (5) damage occurring in transit; (6) normal wear and tear; or (7) the operation or failure of operation of any satellite-based positioning system or differential correction service; or the availability or performance of any satellite-based positioning signal or differential correction signal.

**THE PURCHASER IS RESPONSIBLE FOR OPERATING THE VEHICLE SAFELY.** The purchaser is solely responsible for the safe operation of the vehicle used in connection with the Product, and for maintaining proper system control settings. UNSAFE DRIVING OR SYSTEM CONTROL SETTINGS CAN RESULT IN PROPERTY DAMAGE, INJURY, OR DEATH. The purchaser is solely responsible for his/her safety and for the safety of others. The purchaser is solely responsible for maintaining control of the automated steering system at all times. THE PURCHASER IS SOLELY RESPONSIBLE FOR ENSURING THE PRODUCT IS PROPERLY AND CORRECTLY INSTALLED, CONFIGURED, INTERFACED, MAINTAINED, STORED, AND OPERATED IN ACCORDANCE WITH HEMISPHERE GNSS' RELEVANT USER'S MANUAL AND SPECIFICATIONS. Hemisphere GNSS does not warrant or guarantee the positioning and navigation precision or accuracy obtained when using Products. Products are not intended for primary navigation or for use in safety of life applications. The potential accuracy of Products as stated in Hemisphere GNSS literature and/or Product specifications serves to provide only an estimate of achievable accuracy based on performance specifications provided by the satellite service operator (i.e. US Department of Defense in the case of GNSS) and differential correction service provider. Hemisphere GNSS reserves the right to modify Products without any obligation to notify, supply or install any improvements or alterations to existing Products.

**GOVERNING LAW.** This agreement and any disputes relating to, concerning or based upon the Product shall be governed by and interpreted in accordance with the laws of the State of Arizona.

**OBTAINING WARRANTY SERVICE.** In order to obtain warranty service, the end purchaser must bring the Product to a Hemisphere GNSS approved service center along with the end purchaser's proof of purchase. Hemisphere GNSS does not warrant claims asserted after the end of the warranty period. For any questions regarding warranty service or to obtain information regarding the location of any of Hemisphere GNSS approved service center, contact Hemisphere GNSS at the following address:

**Hemisphere GNSS**

8444 N. 90th Street, Suite 120

Scottsdale, AZ 85258

Phone: 480-348-9919 Fax: 480-348-6370

techsupport@hemispheregps.com



[www.hemispheregps.com](http://www.hemispheregps.com)